

无滚子  
without rollers

带S型小滚子  
with S small rollers type

带P型大滚子  
with P large rollers type

带F型带肩滚子  
with F flanged rollers type

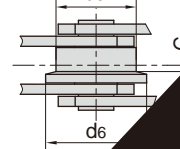
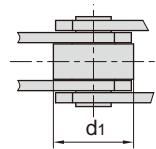
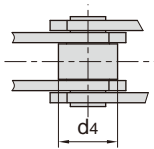
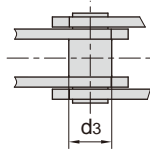

DIN 链号 DIN Chain No.	节距 Pitch							滚子尺寸 Roller dimension		
	P							d1 max	d4 max	d5 max
	mm	mm	mm	mm	mm	mm	mm	mm	mm	
FV40	50.0	63.0	80.0	100.0	125.0	-	-	32.0	20.0	18.0
FV63	50.0	63.0	80.0	100.0	125.0	160.0	-	40.0	26.0	22.0
FV90	63.0	80.0	100.0	125.0	160.0	200.0	250.0	48.0	32.0	25.0
FV112	80.0	100.0	125.0	160.0	200.0	250.0	-	55.0	40.0	30.0
FV140	63.0	100.0	125.0	160.0	200.0	250.0	-	-	-	-
FV180	100.0	125.0	160.0	200.0	250.0	315.0	-	-	-	-
FV250	125.0	160.0	200.0	250.0	315.0	400.0	-	-	-	-
FV315	160.0	200.0	250.0	315.0	400.0	-	-	-	-	-

DIN 链号 DIN Chain No.	内节内宽 Width between inner plates	销轴直径 pin diameter	销轴长度 Pin length
	b1 min	d2 max	l
	mm	mm	mm
FV40	18.0	10.0	25.0
FV63	22.0	12.0	30.0
FV90	25.0	14.0	35.0
FV112	30.0	16.0	40.0
FV140	35.0	18.0	45.0
FV180	40.0	20.0	50.0
FV250	45.0	22.0	55.0
FV315	50.0	24.0	60.0

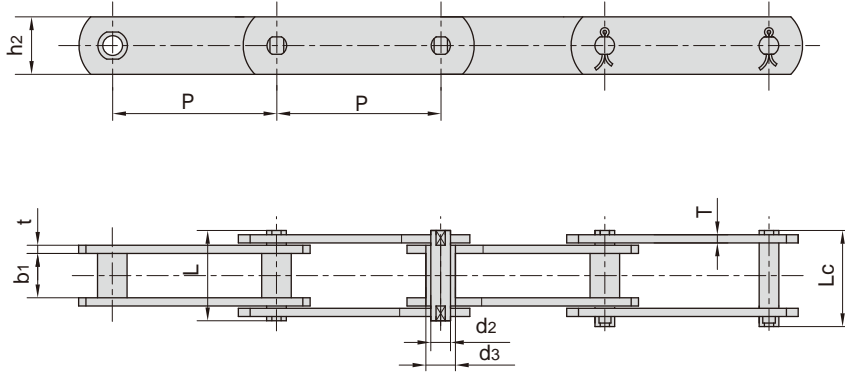

无滚子  
without rollers

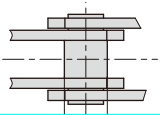

带S型小滚子  
with S small rollers type

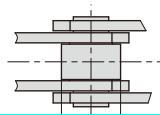

带P型大滚子  
with P large rollers type

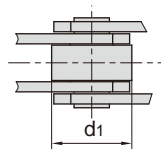

带F型带肩滚子  
with F flanged rollers type

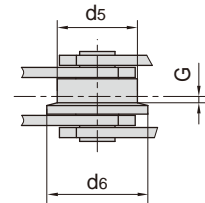

销轴直径 Pin diameter	销轴长度 Pin length		链板高度 Plate depth	链板厚度 Plate thickness	Q min	
d2 max mm	L max mm	Lc max mm	h2 max mm	t/T max mm	Q min kN/lbf	
10.0	38.1	41.5	45.0	4.0	80.0/17985	2.13
14.0	37.0	-	30.0	4.0	60.0/13488	3.89
10.0	44.5	48.0	30.0	4.0	63.0/14162	3.84
14.0	52.0	56.4	35.0	5.0	90.0/20453	6.10
14.0	60.2	64.6	35.0	6.0/8.0	90.0/20453	6.00
16.0	63.0	67.5	40.0	6.0	112.0/25454	8.80
18.0	67.0	71.5	45.0	6.0	140.0/31473	12.76